



## Type 2Q

- Shaft Encoder - □ 63,5 x 63,5
- Shaft  $\varnothing$  1/4 inch to  $\varnothing$  10 mm
- Resolution up to 10.000 ppr
- Standard IP 65 ( IP 66, 67 optional )

### Electrical Specifications

<b>Code:</b>	Incremental
<b>Resolution:</b>	1 to 10.000 ppr (pulses per revolution)
<b>Supply Voltage:</b>	4,5 Vdc min. to 30 Vdc max. ** (45 mA max. - no load)
<b>Output Voltage:</b>	Low: 500 mV max. at 10 mA High: ( $V_{in} - 0,6$ ) at -10 mA ( $V_{in} - 1,3$ ) at -25 mA
<b>Output Current:</b>	30 mA max. load per output channel **
<b>Frequency Response:</b>	300 kHz max. **
<b>Output Format:</b>	Two channel (A, B) quadrature with Index (Z) and optional complementary (A-, B-, Z-) outputs
<b>Phase Sense:</b>	A leads B clockwise (CW) from the mounting end of the encoder
<b>Index:</b>	Gated with Channels A and B high
<b>Accuracy:</b>	+/- 0,8 arc-min.
<b>Outputs:</b>	ASIC Push pull and Differential OL7272 Push-pull and Differential Line Driver 26C31 Differential Line Driver 5V output (with 5V input)
<b>Electrical Protection:</b>	Reverse polarity and output short circuit protected
<b>Noise Immunity:</b>	Tested to EN61000-6-2 : 2005 (industrial environments) Electromagnetic compatibility (EMC) and EN 61000-6-3 : 2007 (residential, commercial, and light-industrial environments) for Electromagnetic compatibility (EMC)

\*\*= It is recommended user not to combine max. Value for all 3 parameters

### Mechanical Specifications

<b>Material:</b>	Housing: Aluminum Cap: Aluminum Hollow Shaft: Stainless steel Note: Lifetime lubricated ball bearings
<b>Weight:</b>	Encoder: ~ 190 gr (6,7 oz) Cable: 60 gr / meter (2,12 oz / meter)
<b>Bearing Life:</b>	> $1,9 \times 10^{10}$ revolutions at rated load
<b>Shaft Speed:</b>	6.000 rpm (max. sustained) IP 65 4.500 rpm (max. sustained) IP 66 / IP 67
<b>Starting Torque:</b>	< 0,02 Nm (2,83 oz-in) at 25° C
<b>Mass Moment of Inertia:</b>	6,0 gcm <sup>2</sup> ( $8,5 \times 10^{-5}$ oz-in-sec <sup>2</sup> )
<b>Shaft Loads:</b>	Axial: 150 N (33,75 lbs) max. Radial: 250 N (56 lbs) max.

### Environmental Specifications

<b>Operating Temp.:</b>	-40° to +85° C
<b>Storage Temp.:</b>	-40° to +85° C
<b>Shock:</b>	100 G / 11 ms
<b>Vibration:</b>	10-2000 Hz / 10 G
<b>Bump:</b>	10 G / 16 ms (1000 x 3 axis)
<b>Humidity:</b>	98 % RH without condensation
<b>IP Rating:</b>	IP 65 / Nema 5 (approx.) IP 66 / Nema 6 (approx.) option IP 67 / Nema 7 (approx.) option

### Connection Options

<b>Cable:</b>	8 leads (0,14 mm <sup>2</sup> , 26 AWG) twisted pairs; shielded
<b>Connector:</b>	5-pin M12 8-pin M12 9-pin M23 12-pin M23 6-pin Mil radial 7-pin Mil radial 10-pin Mil radial

## Output waveform

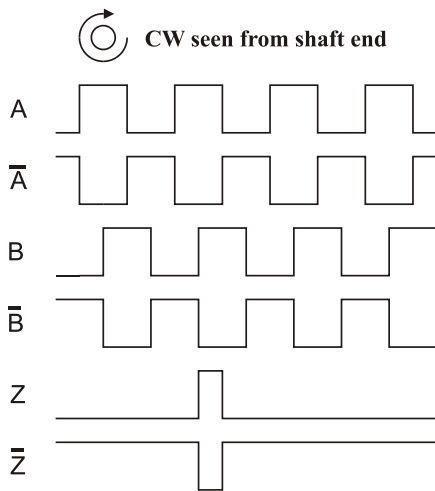

**Channel tolerance** 180 e° +/- 36 e°  
**Phase difference tolerance** 90 e° +/- 18 e°  
**Z channel tolerance** 90 e° +/- 18 e°

## Disk Resolutions (Pulses per revolution)

1	32	125	720	3000
2	36	150	800	3072
5	40	180	1000	3600
6	45	200	1000	4000
7	47	250	1024	4096
8	50	256	1131	5000
10	60	300	1200	8192
12	64	360	1250	9000*
15	70	400	1270	10000*
16	75	455	1500	
18	80	500	2000	
20	90	512	2048	
25	100	600	2400	
30	120	635	2500	

### Other options on request

Pulses per revolution,  
 min. 1 – max. 10.000

\* Operating temperature: -20° C to 50° C

## Mechanical Dimensions

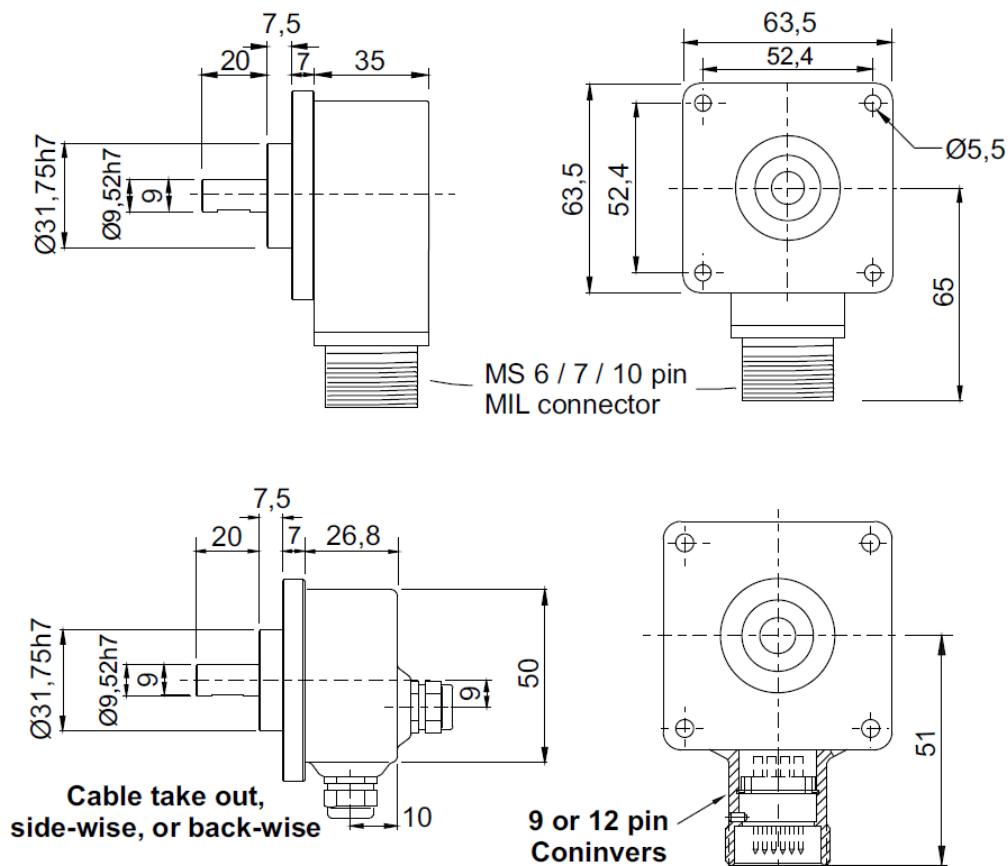

## Output Terminations

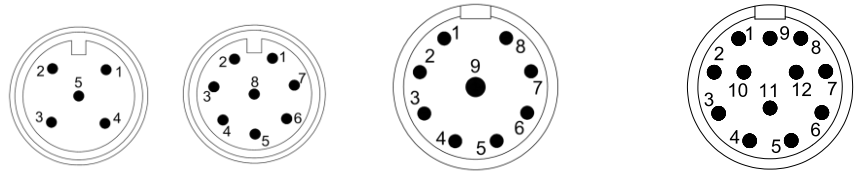

Standard Cable			M12 5 - pin	M12 8 - pin	M23 9 - pin	M23 9 - pin	M23 12 - pin	M23 12 - pin
Channel	Standard Output	Differential Output	Standard Output	Differential Output	Standard Output	Differential Output	Standard Output	Differential Output
Channel	Wire Color		Channel	Channel	Channel	Channel	Channel	Channel
A	Pink	Pink	Vsup	A	A	A	GND	B -
A -	Gray*	Gray	B	Vsup	B	B	NC	NC
B	Green	Green	GND	A -	Z	Z	Z	Z
B -	Yellow*	Yellow	A	B	GND	A -	GND	Z -
Z	White	White	Z	B -	GND	B -	A	A
Z -	Brown*	Brown		Z	GND	Z -	GND	A -
Vsup	Red	Red		GND	Vsup	Vsup	NC	NC
GND	Blue	Blue		Z -	GND	GND	B	B
					Shield	Shield	Shield	Shield
							GND	GND
							NC	NC
							Vsup	Vsup

*GND = Circuit Ground*

*\* Internally connected as GND*

*GND = Circuit Ground*

*Shield = Case Ground*

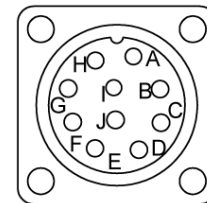
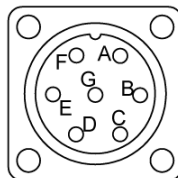
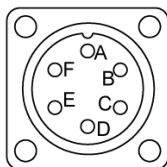

Pin	6-pin Mil Connector		7-pin Mil Connector			10-pin Mil Connector	
	Standard Output	Differential Output	Standard Output	Optional Standard Output *	Differential Output	Differential Output	Optional Differential Output *
Channel	Channel	Channel	Channel	Channel	Channel	Channel	Channel
A	GND	GND	Ch. A	Ch. A	Ch. A	Ch. A	Ch. A
B	Vsup	Vsup	Ch. B	Ch. B	Ch. B	Ch. B	Ch. B
C	Z	A -	Ch. Z	NC	Ch. A -	Ch. Z	Ch. A -
D	B	B	Vsup	Vsup	Vsup	Vsup	Vsup
E	A	A	NC	NC	Ch. B -	NC	Ch. B -
F	Shield	B -	0 volt	0 volt	0 volt	0 volt	0 volt
G			Shield	Shield	Shield	Shield	Shield
H						Ch. A -	NC
I						Ch. B -	NC
J						Ch. Z -	NC

## Ordering Code

Example: 2Q – 1024 – D – 10 – 20 – 65 – 01 – S – 00

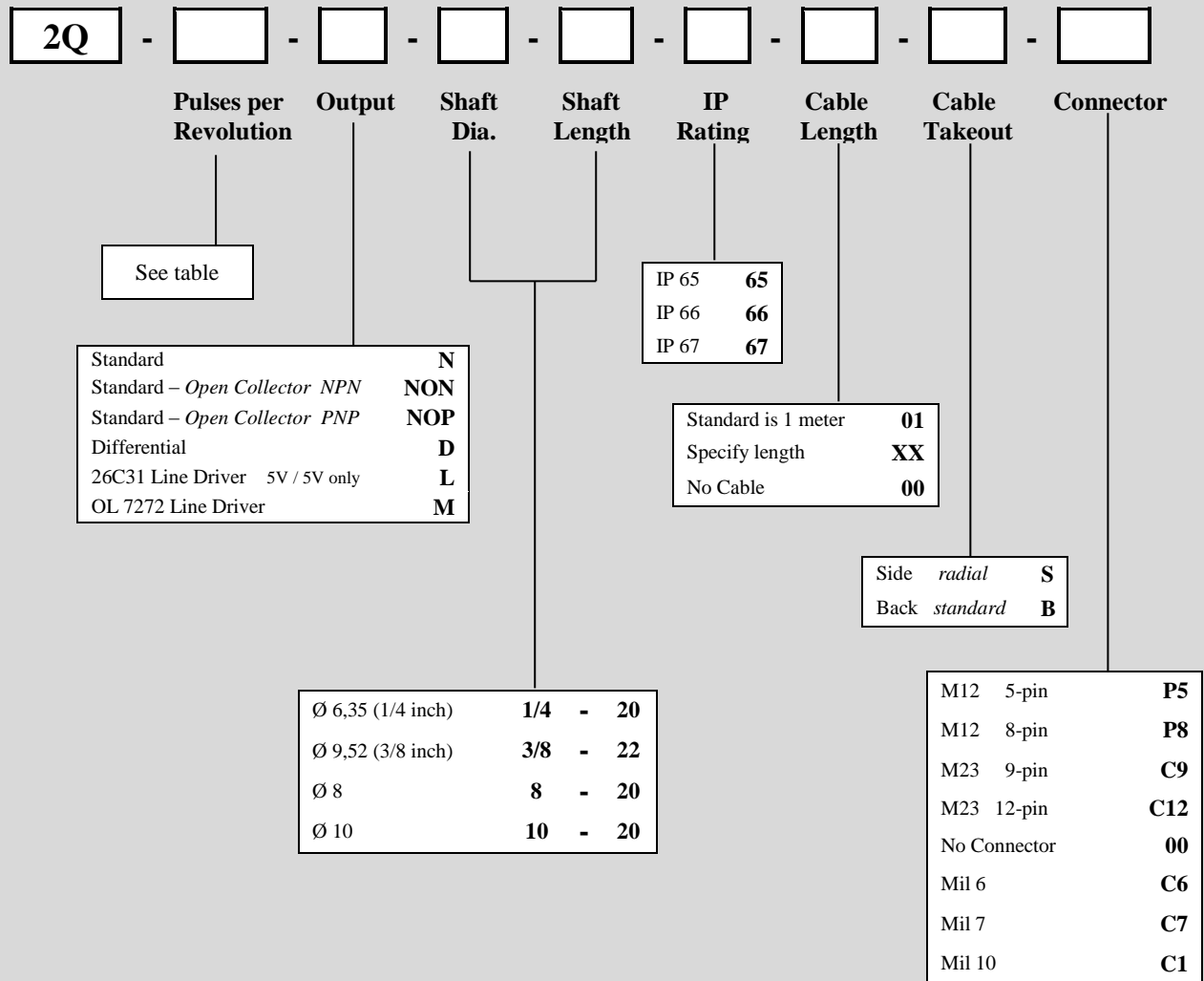

Other options on request:  
Please contact Scancon A/S